



The CHVB-CHVT range is suitable for many general ventilation applications where high system resistances are present; i.e. systems with filters, dampers etc.

Range of cabinet fans, manufactured from galvanised steel sheet with double thickness panel (sandwich type) internally lined with 17 mm thickness fireproof fibre-glass acoustic insulation (M0). All models incorporate direct driven backward curved centrifugal impeller with motor fitted outside of the air stream and suitable for air stream temperature up to 120°C. Available with single phase or three phase motors in 4 poles.

Motors

Speed controllable by Voltage. Three phase motors are speed controllable by inverter. All the motors are IP55 Class F insulation, with thermal protection. Electrical supply:

- Single phase 230V-50Hz. (CHVB)
- Three phase 400V-50Hz. (CHVT)

On request

Three phase 230/400V-50Hz (CHVT).

Specific applications



Officially approved to EN12101-3 standard. Certificate n° 0370-CPD-0666



Continuous



Car parks



Commercial and industrial kitchens

Versatile assembly

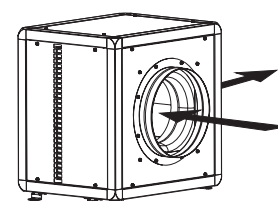
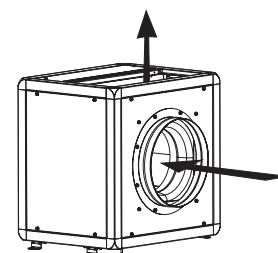
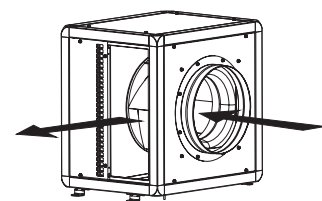

Backward curved centrifugal impellers

To prevent accumulation of dirtiness. Dynamically balanced.

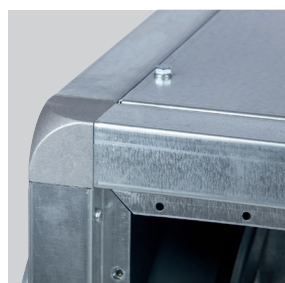

Robustness

Quality finishing, with aluminium corners providing a high robustness.



Easy to mount

All models are supplied with four mounting feet to facilitate installation.

TECHNICAL CHARACTERISTICS

Before installation check that the product electrical characteristics listed on the data plate label (voltage, power, frequency, etc.) match those of the intended electrical supply.

Model	Speed (rpm)	Maximum absorbed power (W)	Maximum absorbed current (A)	Maximum airflow (m³/h)	Sound pressure level at 1,5 m (dB(A))	Weight (kg)	Speed controller*
SINGLE-PHASE							
CHVB/4-3000/315	1390	305	1,45	2.670	58	46	REB-2,5 N
CHVB/4-4000/355	1315	530	2,3	4.300	64	75	REB-5 N
CHVB/4-6000/400	1370	1060	5,05	6.480	70	90	REB-10
THREE-PHASE							
CHVT/4-3000/315	1410	320	0,86	2.770	58	46	RMT-1,5
CHVT/4-4000/355	1420	620	1,5	4.310	64	75	RMT-2,5
CHVT/4-6000/400	1295	1070	1,95	6.560	70	90	RMT-2,5

* Three phase speed controllers (RMT) are suitable for 400 V

ACOUSTIC CHARACTERISTICS

Sound power level spectrum in dB(A) at the corresponding frequency band (Hz):

Working point positions: LP: Low pressure;
MP: Medium pressure;
HP: High pressure

4-3000/315		63	125	250	500	1000	2000	4000	8000	LwA
Inlet	LP	44	70	67	67	69	68	63	60	76
	MP	44	64	69	60	61	60	57	52	72
	HP	44	62	64	71	71	67	63	55	76
Outlet	LP	42	72	67	68	69	69	63	60	77
	MP	40	66	64	66	68	66	61	54	73
	HP	39	62	63	64	67	66	61	53	72
Radiated	LP	37	63	60	55	55	55	54	48	66
	MP	37	57	62	48	47	47	48	40	64
	HP	37	55	57	59	57	54	54	43	64

4-6000/400		63	125	250	500	1000	2000	4000	8000	LwA
Inlet	LP	51	70	70	73	83	78	71	74	85
	MP	50	64	68	73	75	71	69	65	79
	HP	55	68	71	75	79	75	71	64	82
Outlet	LP	53	73	73	75	84	82	73	75	87
	MP	49	68	68	70	72	69	70	66	78
	HP	58	70	72	72	72	70	70	63	79
Radiated	LP	47	59	58	60	64	58	53	55	68
	MP	46	53	56	60	56	51	51	46	64
	HP	51	57	59	62	60	55	53	45	67

4-4000/355		63	125	250	500	1000	2000	4000	8000	LwA
Inlet	LP	51	69	71	70	72	71	69	75	80
	MP	50	67	69	70	72	67	67	69	78
	HP	51	67	67	72	76	71	68	63	79
Outlet	LP	50	74	73	73	72	72	69	66	80
	MP	47	74	70	70	70	68	64	60	78
	HP	48	65	66	66	67	65	63	56	73
Radiated	LP	46	65	63	58	56	54	56	58	69
	MP	45	63	61	58	56	50	54	52	67
	HP	46	63	59	60	60	54	55	46	67

PERFORMANCE CURVES

- q_v : Airflow in m^3/h and m^3/s .
- p_{sf} : Static pressure in mmWG and Pa.
- Dry air at 20°C and 760 mmHg.
- Performance data in accordance with ISO 5801 and AMCA 210-99 Standards.
- Sound pressure levels (L_p dB(A)) measured at 1,5 meters distance. (At the inlet, in black, at the discharge, in blue).

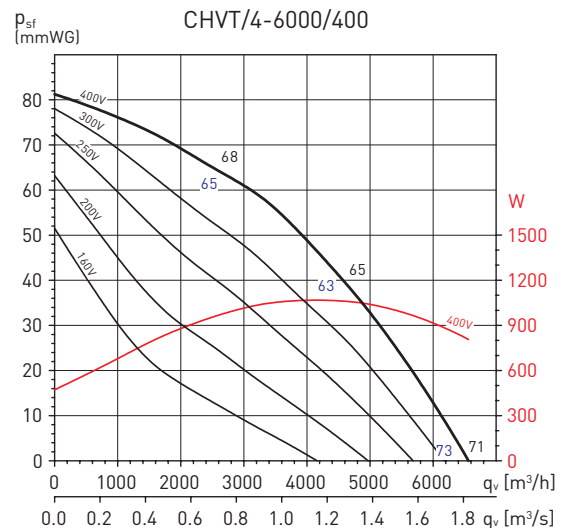
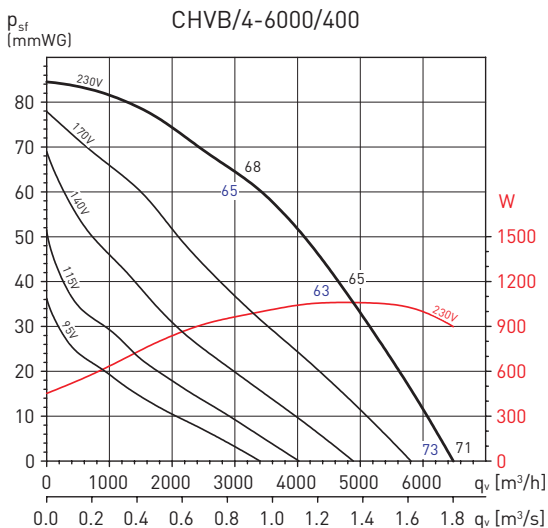
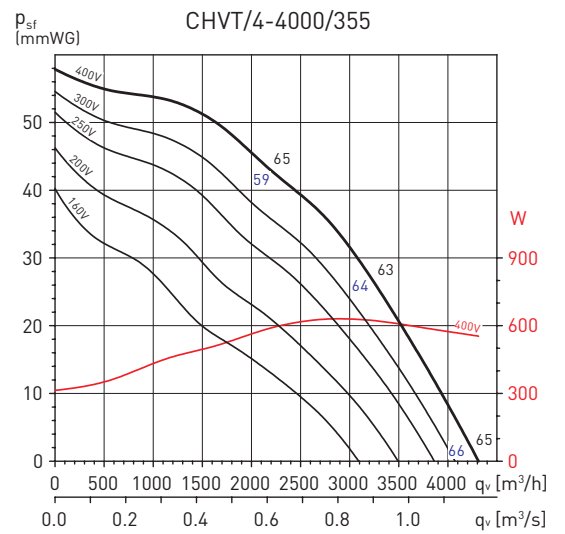
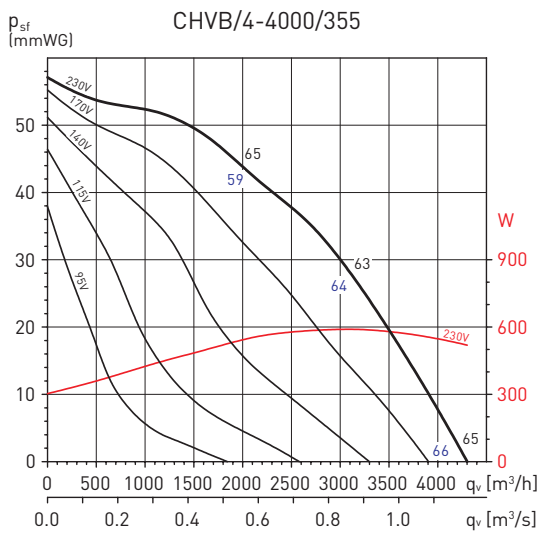
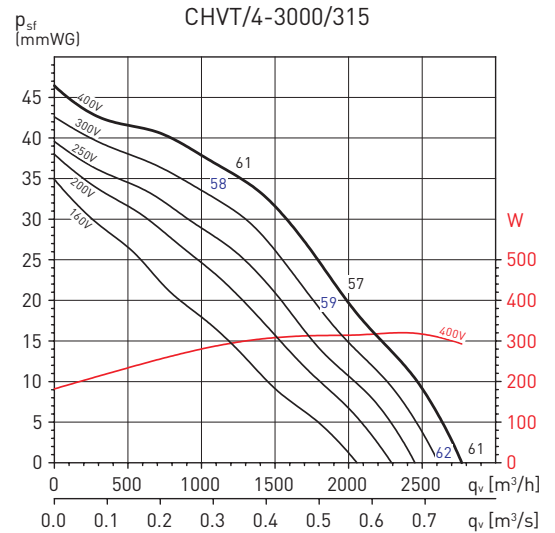
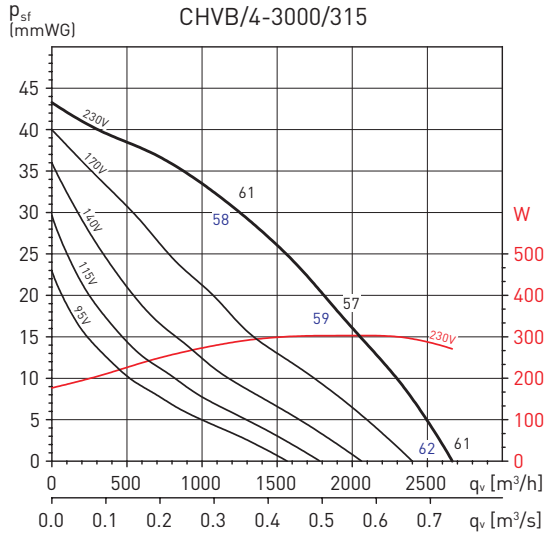

DIMENSIONS (mm)

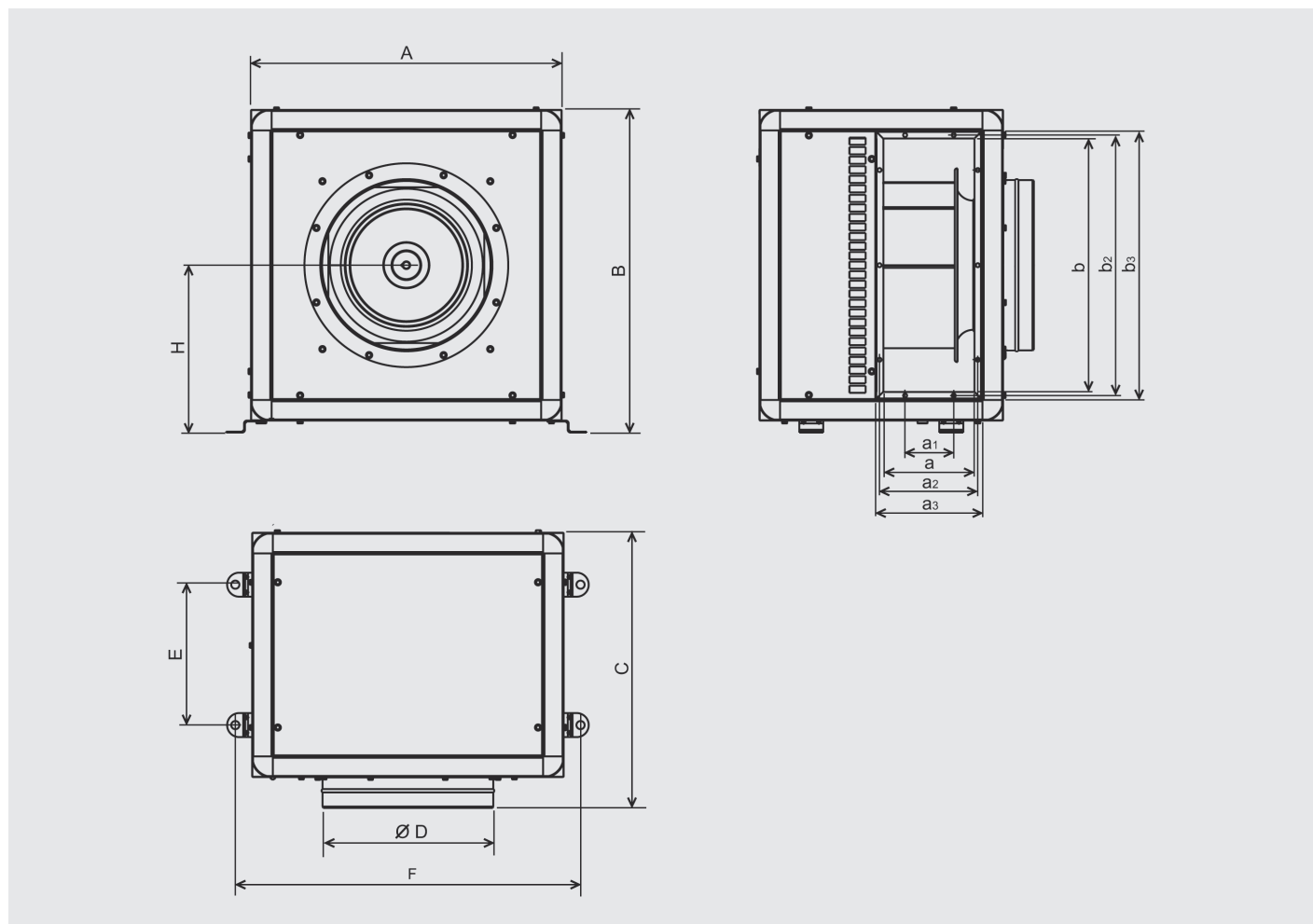

Model	A	B	C	D	E	F	H	a	a1	a2	a3	b	b2	b3
CHVB/4-3000/315	548	573	527	315	247	618	299	149	118	162	183	429	441	463
CHVB/4-4000/355	648	673	572	355	292	718	349	187	167	201	221	529	541	563
CHVB/4-6000/400	798	823	586	400	306	868	424	196	169	210	230	679	694	713
CHVT/4-3000/315	548	573	527	315	247	618	299	149	118	162	183	429	441	463
CHVT/4-4000/355	648	673	572	355	292	718	349	187	167	201	221	529	541	563
CHVT/4-6000/400	798	823	586	400	306	868	424	196	169	210	230	679	694	713

MOUNTING ACCESSORIES



FD
Circular coupling flange
To fit to the outlet.

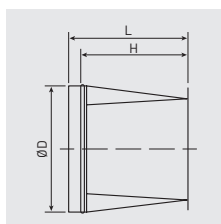

Model	Ø D	L	H
FD-3000	315	450	400
FD-4000	355	450	400
FD-6000	400	450	400



ACOPEL F400 N
Circular flexible connector.
Certified F400-120.

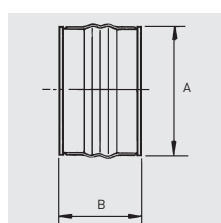

Model	ØA (mm)	B (mm)
ACOPEL F400-315/160 N	315	160
ACOPEL F400-355/160 N	355	160
ACOPEL F400-400/160 N	400	160



ACOP RECT F400
Rectangular elastic coupling
To fit to the outlet.
Avoids transmission of vibrations.

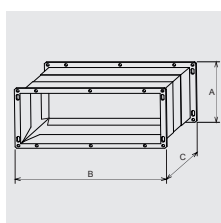

Model	A	B	C
ACOP RECT F400-3000	180	459	143
ACOP RECT F400-4000	219	559	143
ACOP RECT F400-6000	228	709	143



CTI CHV
Outdoor cover
For outdoor installations.

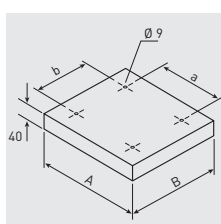

Model	A	B	a	b
CTI CHV-3000	575	490	358	343
CTI CHV-4000	675	535	442	402
CTI CHV-6000	825	545	593	417



KSE
Vibration damping supports
Rubber vibration damping supports that reduce vibrations and attenuate the noise of the installation.
(1 KSE = 4 supports in a bag).

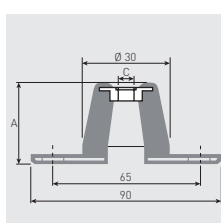

Model	Weight of fan	A	C
KSE-45	40 – 180 kg	24	M8
KSE-70	80 – 280 kg	38	M8



APC
Round outlet guards
Discharge protection guards for direct connection to the inlet-outlet flange.

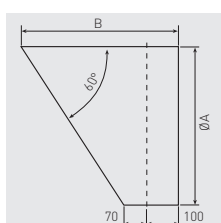

Model	Ø A	B
APC-315	315	342
APC-355	355	365
APC-400	400	391

ELECTRICAL ACCESSORIES



REB
Single phase electronic speed controllers.



RMB/RMT
Single and three phase auto transformer speed controllers.