



Range of domestic MVHR units with high efficiency counterflow heat exchanger (up to 92%) and low consumption EC motors. The units assures a continuous and balanced ventilation system, extracting moist stale air from the wet rooms and at the same time introducing a tempered and filtered fresh air to the habitable rooms. The optimized design allows compliance with the highest standards assuring a very low leakage level, high thermal insulation and a minimal sound level. The integrated humidity sensor allows an automatic function tracking the indoor humidity and proportionally adjusting the fans speed.

The unit contains as a standard iso coarse 65% (G4) filters in the supply and extract airflows to clean the incoming air and protect the heat exchanger. For higher air quality an optional Pm1 50% (F7) filter can be installed in the supply air channel.

An integrated 100% bypass is activated either automatically or manually. The bypass is particularly useful when the indoors temperature is higher than outdoors and free cooling is preferable.

INSTALLATION FRIENDLY

A versatile product with advantages for installation.

The airflow direction paths can be handed to allow for alternate on-site configurations of duct routing.

A range of accessories lets the end user tailor the functions of the system to their specific requirements.



DESIGNED FOR AN EASY INSTALLATION

Characteristics:

- High efficiency counterflow heat exchanger.
- Low consumption EC motors.
- Minimal sound level.
- Automatic/manual bypass.
- Install friendly.
- User friendly.
- Customisable.

Optional accessories:

- Integrable pre heater.
- Integrable VOC sensor.
- Communication module.
- Integrable constant airflow module [Servoflow].

Specific applications



Domestic MVHR Single dwelling



Domestic MVHR Multi dwelling blocks



Heat recovery



Touch screen

Remote (wired) touch screen display panel.

- Functions:
- Easy control.
 - Speed settings.
 - Manual bypass.
 - Boost activation.
 - Automatic mode activation.
 - Dirty filter alarm.



Connectair

Through the optional SPCM module, the unit can access Connectair, S&P's IoT that provides access to a new way to enjoy your ventilation.



Installer friendly

Simple access to all the components.

TECHNICAL CHARACTERISTICS

It is essential to check that the electrical characteristics (voltage, current, frequency, etc.) of the motor which appear on the motor plaque are compatible with those of the installation.

Model	Voltage (V)	Maximum flow rate at 100 Pa (m ³ /h)	Sound pressure level, at 1.5m (dB(A))	Maximum absorbed power (W)	Efficiency ErP (%)
SABIK 210	230	225	36,5 (140 m ³ /h a 100 Pa)	91	87
SABIK 350	230	375	37,7 (250 m ³ /h a 135 Pa)	145	85
SABIK 500	230	550	43,1 (400 m ³ /h a 150 Pa)	265	85

CHARACTERISTIC CURVES

- q_v = Flow rate (m³/h).
- p_{sf} = Static pressure in Pa.
- P_{abs} = Absorbed power (W).

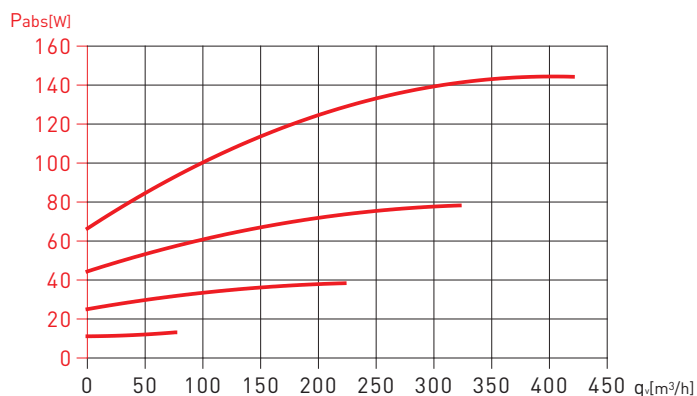
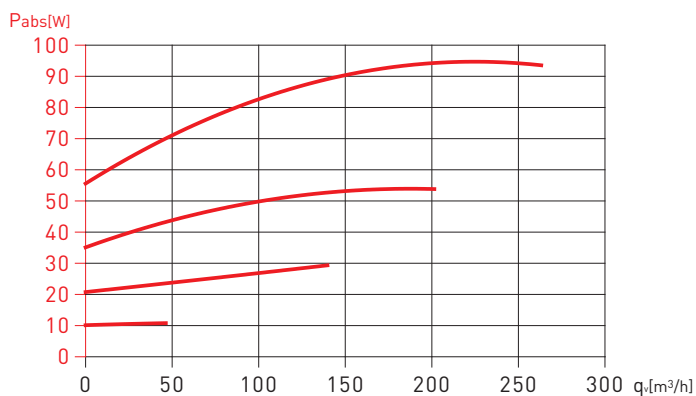
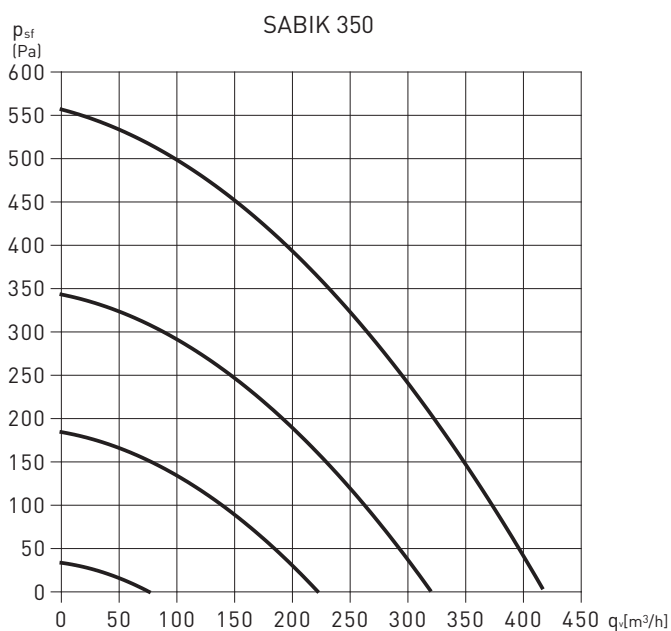
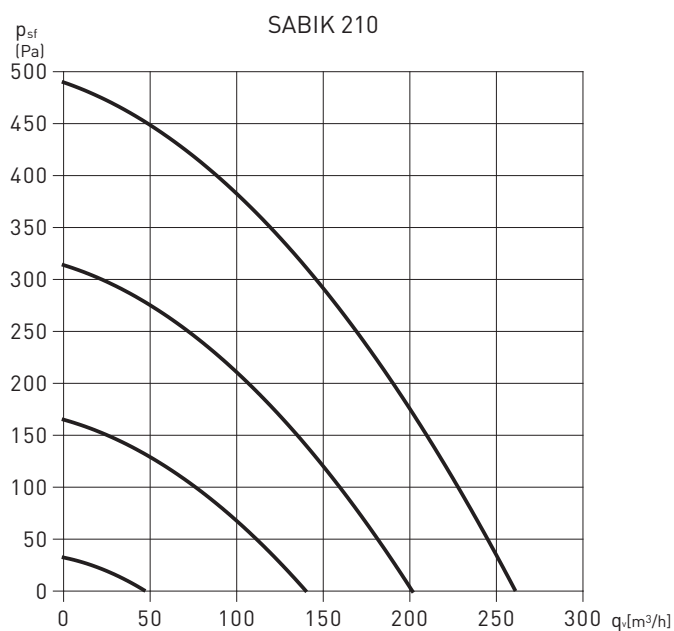

CHARACTERISTIC CURVES

- q_v = Flow rate (m^3/h).
- p_{sf} = Static pressure in Pa.
- P_{abs} = Absorbed power (W).

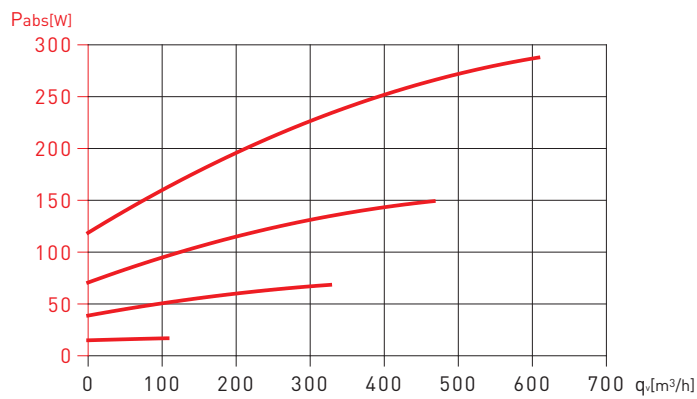
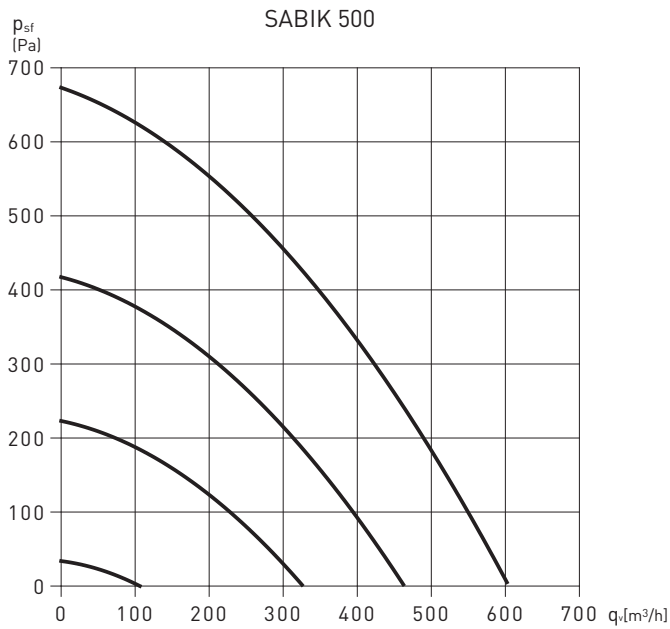

DIMENSIONS (mm)

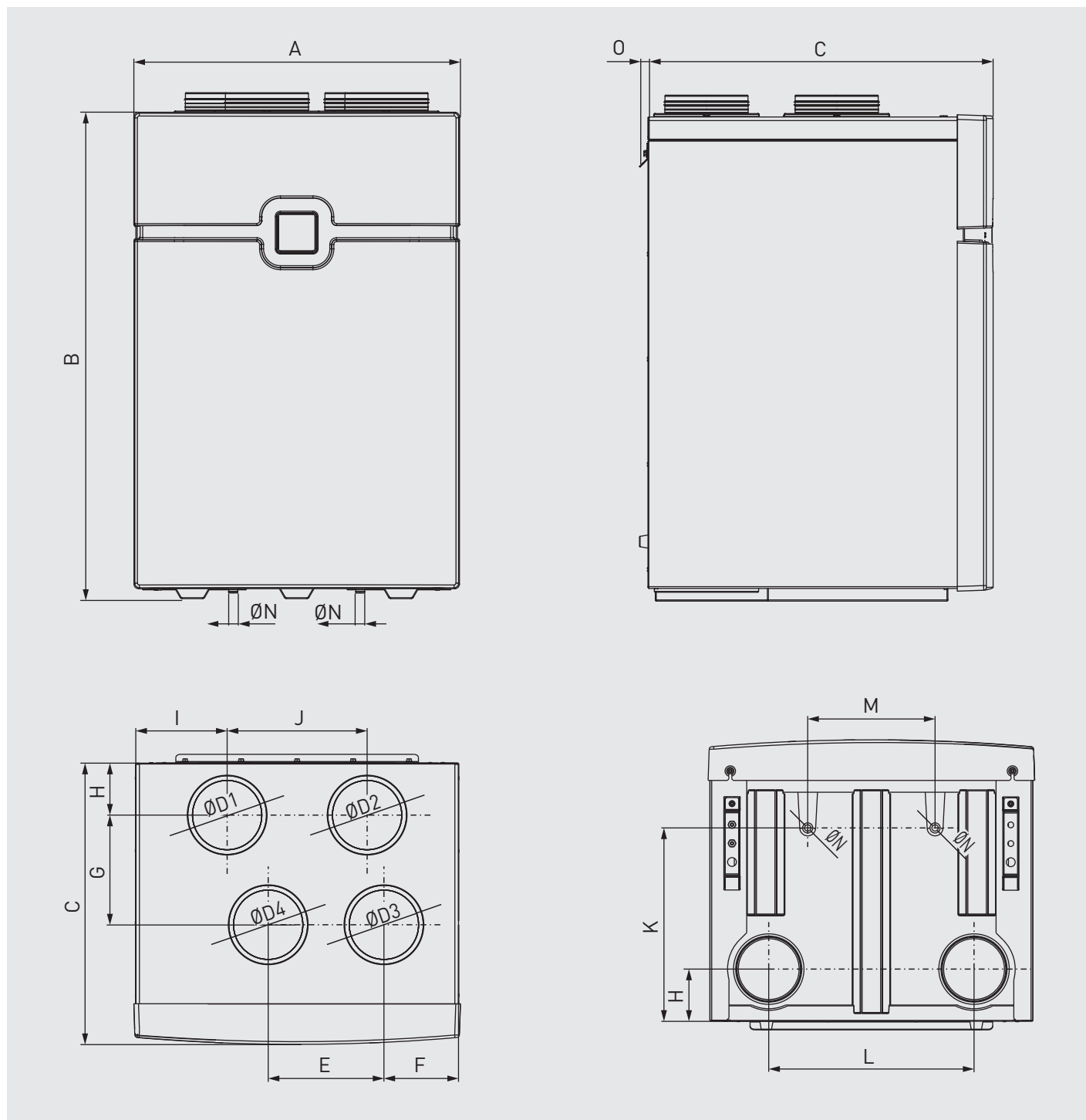

Model	A	B	C	D1	D2	D3	D4	E	F	G	H	I	J	K	L	M	N	O
SABIK 210	600	995	460	125	125	125	125	215	125	180	94	161	215	313	392	267	21	19
SABIK 350	700	1046	603	150	150	150	150	248	160	235	111	196	300	414	440	273	21	19
SABIK 500	700	1046	753	180	180	180	180	257	153	280	126	196	300	493	440	273	21	19

SABIK SPECIFIC ACCESSORIES



SPCM
Communications module.



SABIK F
Filter replacement sets G4/G4 and G4/F7.



SABIK-PH
Preheating coils can be integrated into the equipment. Plug&Play.



SABIK-VOC
VOC probe can be integrated into the unit. Plug&Play.



SABIK-WMC
Wall spacer bracket.



SABIK-NEMBUS-SF
Constant flow module that can be integrated into the unit. Plug&Play.

ASSEMBLY ACCESSORIES

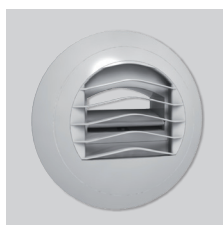

**BARJ
BARP**
Auto-adjustable suction inlets.



BDOP
Supply and extraction inlets.



RDR
Auto-adjustable flow regulators. To be installed inside the duct.

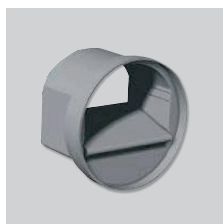

RD BP
Auto-adjustable low-pressure flow regulators. (20-100 PA) To be installed inside the duct. 80mm diameter. Flow rate: 15 or 30 m³/h.



RD BP SM
Auto-adjustable flow regulators. To be installed inside the cuff of the BDOP nozzles. 80mm diameter. Flow rate: 15 or 30 m³/h.

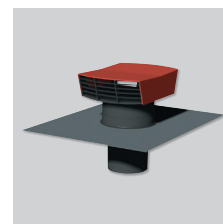

CT
Roof covers.



ADRF 100/80
Reducer to connect rigid different diameter ducts.



GPR-ISO
Rigid insulated ducts.



**GP
GPX
GP-PRO
GP-ISO**
PVC ducts.

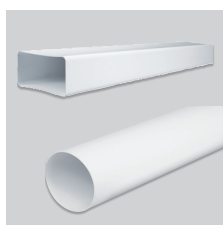

TUBREC
Rectangular ducts in flame-retardant plastic.



LAF
Flexible acoustic connection. Length: 0.5 and 1m models.

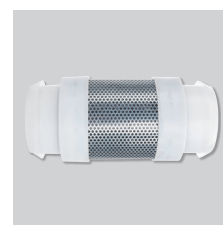

LA
Acoustic connection.



FLEXIREC
Semi-flexible oblong ducts.

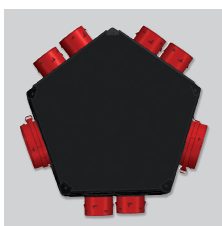

PLENUM UNI EXT 6+1
Isolated delivery plenum with outlet Ø 125/150-160 mm, 1 kitchen Ø 125 mm outlet and up to a maximum of 6 bathroom Ø 80 mm outlets.

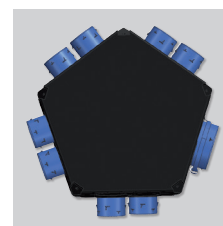

PLENUM UNI IMP 8
Isolated delivery plenum with suction Ø 125/150-160 mm, and up to a maximum of 8 outlets for dry areas (dining room, living room, bedrooms) Ø 80 mm.