

RE Fans

Operating Conditions, poloha

Fans are designed for indoor and outdoor applications, and to transport air without solid, fibrous, sticky, aggressive, respectively explosive impurities. For outdoor use, the fan must be provided with protective finish coat (with the exception of the production of labels) and possibly the roof. Air mass may not contain chemicals that corrode or degrade zinc, aluminum and plastics.

RE fans can work in any position. When placed under the ceiling, it is appropriate, for better access to the terminal and engine to mount fan opening panel (bowl) engine facing downwards. If the air is saturated with moisture or threatens inside the fan intensive steam condensation, it is suitable to mount the fan opening panel (cup) of the motor upwards while maintaining service access to the terminal block and the motor.

Specific operational and technical parameters of individual types of fans are listed in a catalog of Vento duct units.

Warning! Due to the use of EC motors with permanent magnets it is not possible to operate either storage or transport RE fans at ambient temperatures below -40 ° C!

Mechanical Installation

- The fan must be checked carefully before its installation, especially if it was stored for a longer time. In particular, it is necessary to check all parts and cable insulation for damages, and to see whether the rotary parts can rotate freely.
- It is recommended to insert the DV elastic connections in front of and behind the fan.
- It is advisable to always place the KFD, VFK, respectively VFT metal grease air filter in front of the fan to protect the fan and duct against dirtying and dust fouling.
- If the fan is installed in such a way that persons or objects can come into contact with the impeller, the guard grid must be mounted.
- The fan must be suspended by separate suspensions so that no loading can be transferred to the elastic connections or connected duct. The fan suspensions must always include attenuation and anti-vibration elements (e.g. silent blocks).
- Anchoring to the ceiling using steel anchors and "Z" suspensions of suitable load capacity (e.g. suspensions with integrated silent blocks of 80 kg load capacity) riveted to the fan casing or ancillary construction is recommended.
- Before installation, paste self-adhesive sealing onto the connecting flange face. To connect individual parts of the Vento system, use galvanized screws and nuts M8 (M10 only for 90-50 and 100-50 sizes). It is necessary to ensure conductive connection of the flange using fan-washers placed on both sides at least on one flange connection.
- To brace the flanges with a side longer than 40 cm, it is advisable to connect them in the middle with another screw clamp which prevents flange bar gapping.
- For RE fans with hinged panel the impeller cover screws cover should be carefully tighten in the closed position.

Figure 13 – Anchoring the fan



Figure 14 – Suspension using perforated strips

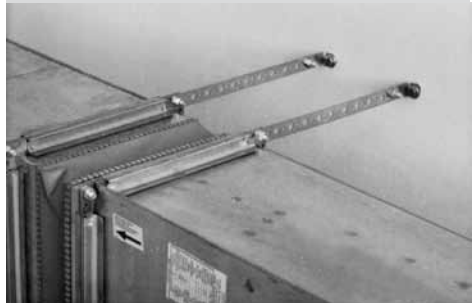

Wiring

- The wiring can be performed only by a qualified worker licensed in accordance with national regulations.
- Electrical installation is completed according to the type of fan either with a separate box with IP 44 / IP 54 for power connection and a box with IP 44 for control connections (Figure 15) or double-segment terminal box built under a cover on the body of the motor (IP 54) (Figure 16).
- Motor electronics ensures even three-phase fan correct direction of rotation regardless of the phase sequence.
- Small fan types have a speed indicator which allows tracking of fan speed. Larger models have an output potential free relay contact for fault reporting. See diagrams (Figure 17).
- To connect fan motors following cables are recommended, for example:
CYKY – J 3x1,5 – single-phase motor supply
CYKY – J 4x1,5 – three-phase motor supply
JYTY – O 2x1 – control signal 0–10 V, and/or JYTY – O 3x1 using +10 V power source from the fan and connecting potentiometric ORP controller.

Note: If 20 m in length or less shielded cable is not required and can be used eg. H05VV-F 2x1, respectively. H05VV-F 3x1) H05VVH2 - F 2Ax0,75 - EC motor fault (if available)

To avoid electromagnetic interference sufficient distance from powerlines control lines and motor lines must be guaranteed. The length of the control cables must be max. 30

RE Fans

Figure 15 – double-segment terminal box



Figure 16 – 2 separate terminal boxes(motor/cables)

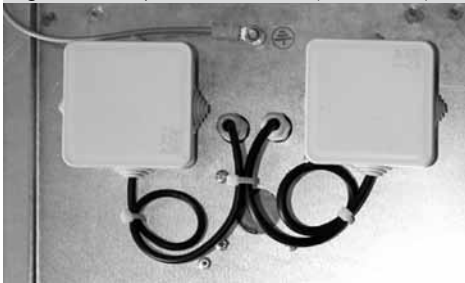

m, 20 m lines must be shielded. When using a shielded wire must be connected to the protective shielding conductor on only one side, i.e. only on the device (which must be as short as possible and have low inductance).

Motor protection

As standard all motors provide permanent automatic checking of internal temperature. EC motor electronic controls operation of the fan to avoid damage in case of incorrect operating conditions (blocked, repeated overheating, phase loss), the fan stops and or indicates a failure (models equipped with a fault relay). Fan operation resumes after activating the protective functions and the removal of the subsequent problems, so chilling. etc.

Warning! Application of this operational behavior (not-indicated shutdown) must be evaluated in the context of the project and HVAC control system. When checking, or performing fan service works it is necessary always disconnect the power supply to avoid injury when the fan starts up automatically after cooling.

Note: RE 50-30/28-SE, RE 60-35/35-SE, RE 70-40/40-SE, RE 90-50/50-SD and RE 100-50/50-SD fans have, as standard, built-in Modbus communication (terminals A, B, in the X1 junction box X1 - control circuits). Modbus communication within RE fan series is not used by default. Terminal description is therefore not included in the above wiring diagrams. Modbus communication is used only for the service purposes (and/or for special fan control methods).

Figure 17 – wiring according to types

a) Single-phase fans

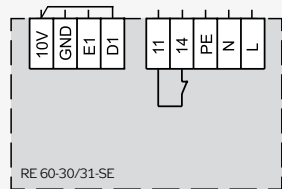
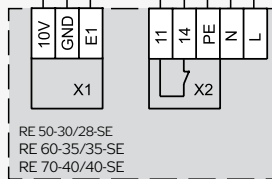
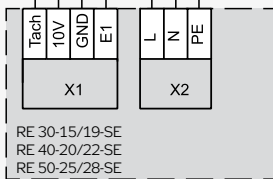

a) Three-phase fans

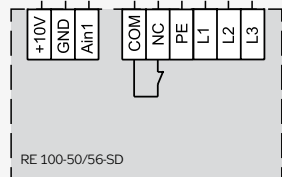
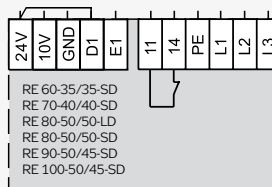
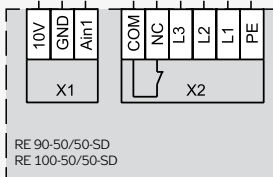

Terminals description (summary):

L1, L2, L3 – power supply

N – neutral conductor

PE – protective conductor

11, 14 – Summary fan failure (loading of the 250 V AC, 2 A contact)

NC, COM – Summary fan failure (loading of the 250 V AC, 2 A contact)

D1 – digital input (on/off)

E1 – input 0–10 V DC

Ain1 – input 0–10 V DC

10V – voltage source 10 V DC

24V – voltage source 24 V DC

GND – ground

RE Fans

See complete operating manuals of EC motors)

Fan output control

- Changing the speed a performance of RE fans can be fully controlled. Speed changes via an analog input control voltage (0-10 V DC), while fan control (engine electronics) provides constant activating" voltage of 10 V DC or it is possible to control the fan via an external 0-10 V signal from a complex control system.
- Potentiometric ORP controller (for manual fan control) is available as an accessory.
- Using voltage 0–10 V, respectively using potentiometric ORP controller it is possible to control two or more fans connected together in parallel to control signal (max. - according to max. possible load supply voltage of 10 V) but there always must be "activating" voltage of 10 V applied only from one source or fan (may not be connected to other +10 V fan output), see Figure 18.
- The control voltage is also necessary to use to stop the fan from operating (standard and disconnecting power) - see above Operating conditions.
- For the course of speed control (the flow) of the fan according to the level of the input signal, see Figure 19 and Table 1.

Activation and Start-up

- The fan is being started when fitted to the duct network, for which it was designed, applying the supply voltage and control signals – refer to control the fan power.
- The loading takes place by increasing the fan flow, i.e. throttling release.

Figure 19 – the course of fan power control

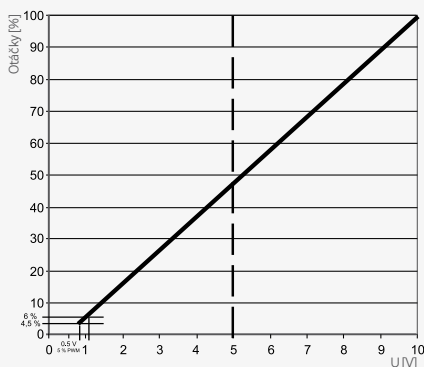
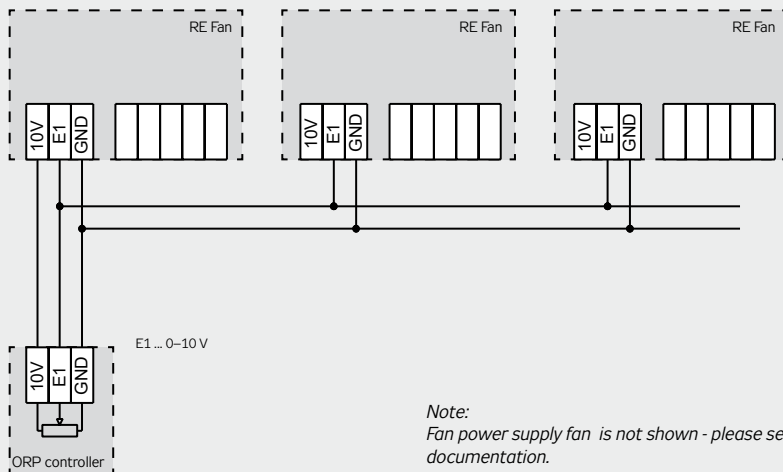

Table 1 – The course of fan power control

DC Control Voltage [V]	Operation State	Fan Speed (%)
0-1 ⁽¹⁾	STOP	0
>1 ⁽¹⁾	CHOD	viz obr. 1
10	CHOD	100

Figure 18 – Connection of ORP controller to RE fans



Note:
Fan power supply fan is not shown - please see fan documentation.

(1) in the area around the level of the control signal (1 V) it is necessary to count with hysteresis switching on/off

- After starting the fan, it is appropriate to measure current, which can not exceed +5% maximum allowed current I_{max} on the nameplate. We recommend measuring the current using device enabling measurement of the effective value of the non-sinusoidal current (true RMS).
- If there are higher values of current, it is necessary to check regulation of duct network or the smooth rotation of the impeller.

Operation, Maintenance and Service

- During operation it is especially necessary to oversee the proper fan operation, smooth running, take care of the cleanliness of the fan and its surroundings, burden the fan only within the range of its power characteristics.
- When removing any faults it is necessary to check the control voltage, which must be higher than 1 V⁽¹⁾.
- Even if then the fan does not run, it is necessary to carefully examine whether the mains voltage is disconnected, and check the fan for foreign objects and if the fan rotates freely. If, after switching (pause min. 60 sec), the fan does not run again, we recommend you contact our service department.

Warning! When performing any maintenance or repairs, the device must always be disconnected from the power supply!

After disconnecting the mains voltage, dangerous charge may occur at the terminals. Wait min. 5 min before opening the terminal.

To ensure voltage-free state, the device must be provided with a stand-alone and lockable switch (or with a control unit equipped with such a switch).

(1) in the area around the level of the control signal (1 V) it is necessary to count with hysteresis switching on/off